

NODI

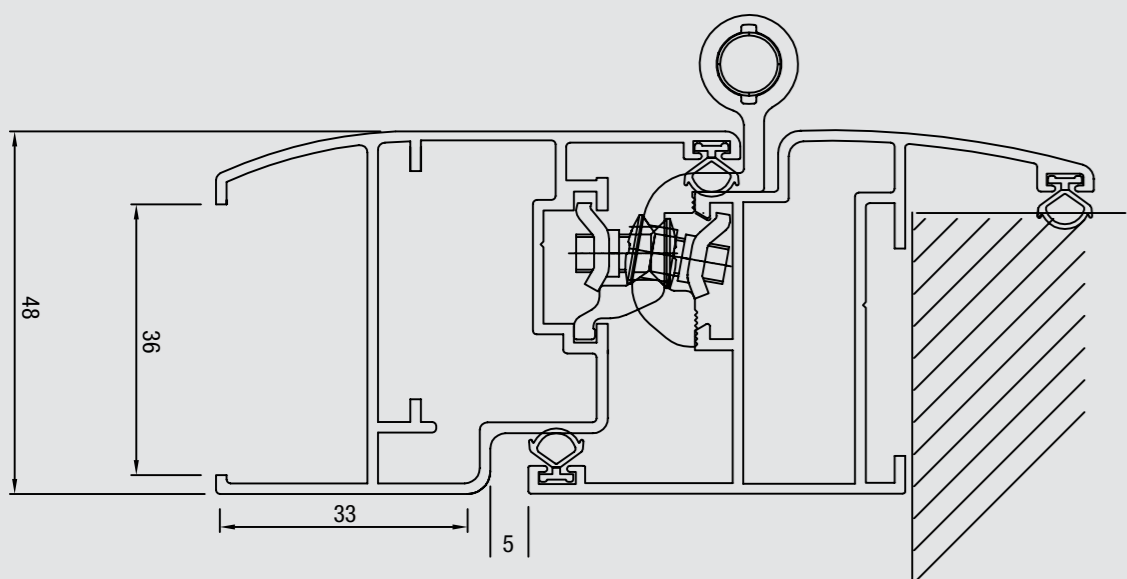
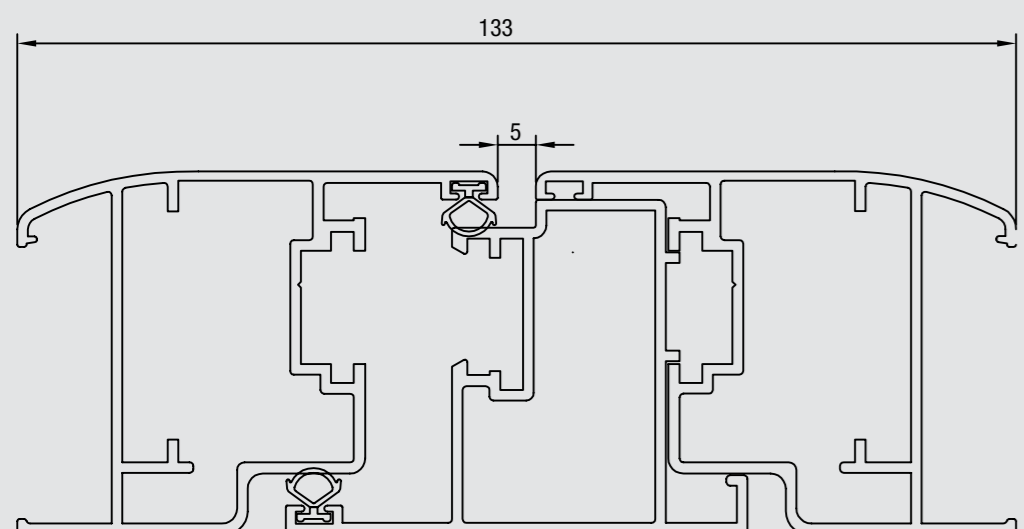
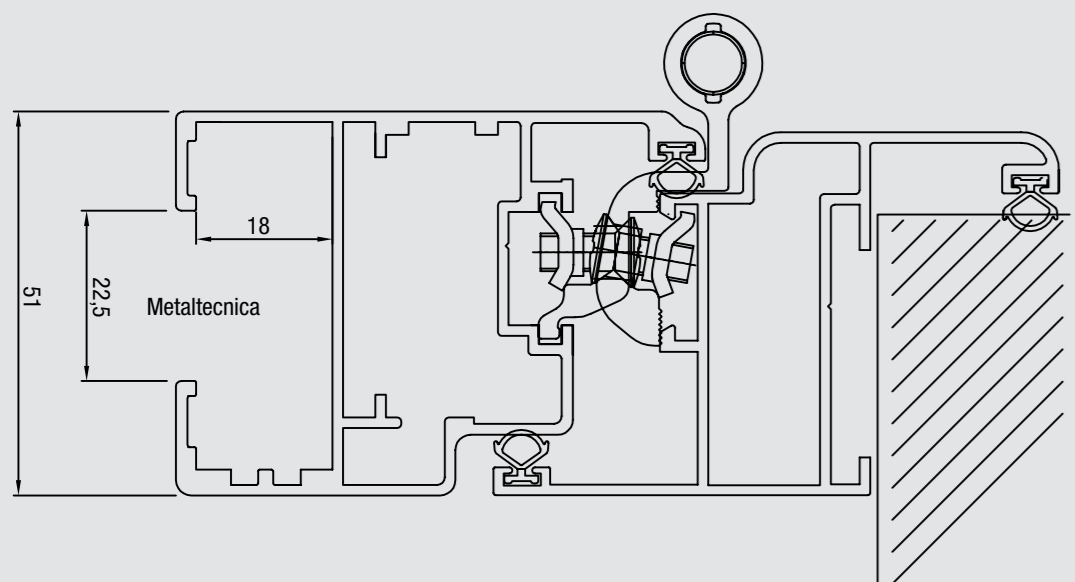

PERSIANA Venezia

Assicura un ottimo rapporto tra funzionalità, qualità-prezzo ed estetica.

Offre una gamma completa di forme e colori, per un utilizzo nelle nuove costruzioni e nelle ristrutturazioni.

Richiede poca manutenzione per una lunga durata nel tempo.



Giacinto Callipo & Figli s.r.l.
Zona Industriale
89843 Maierato (VV)
Tel. (pbx) 0963 996411

www.callipo.it

NUMERO VERDE FAX
800 901 503



GRUPPO
CALLIPO

PROFILI COMPLEMENTARI

Cod.	Profilo	Peso Kg/m	Cod.	Profilo	Peso Kg/m
R5852		1.700	AR0029		0.420
R6017		1.175	AR0028		0.340
R6825		0.527	E41405		1.304
R3518		0.506	E41311		1.550
MC168949		0.502	E41310		1.092
MC152860		0.712	E41305		0.938
R5073		0.590	B1240		0.354
R5580		0.466	B0976		0.365
R4424		0.525	G1088		0.374
R3966		0.384	NC3644		0.181

ACCESSORI

Cod.	Prodotto	Cod.	Prodotto
GS0143	Cerniera a 2 ali	GS1150	Cremonese unica
GS2111	Catenaccio	GS2243	Kit apertura esterna
GS2114	Terminale asta	GS2253	Perno di trascinamento
MS4212	Incontro aste	MG402DR	Battuta telaio infilare base rigida
TRV01	Tappi riporto	ES0233	Giunto fascia E41405
LM0421	Squadretta	TP12	Giunto fascia E41310 - E41311
PR01	Registro telaio		

PROFILI

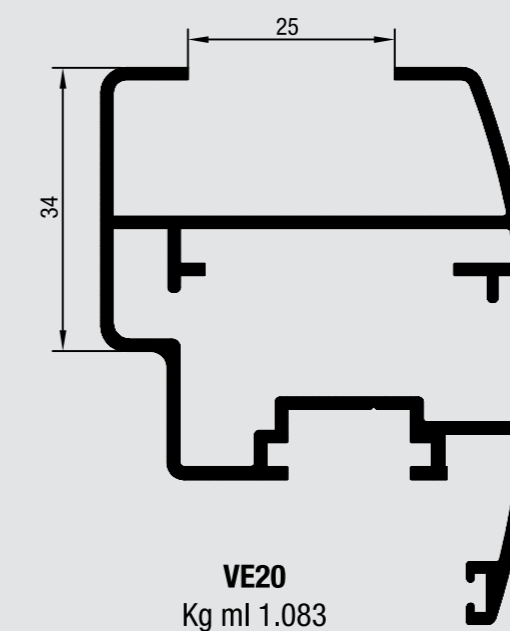
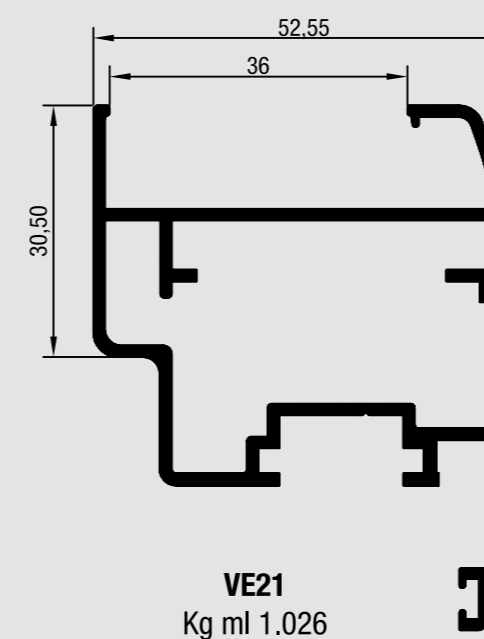
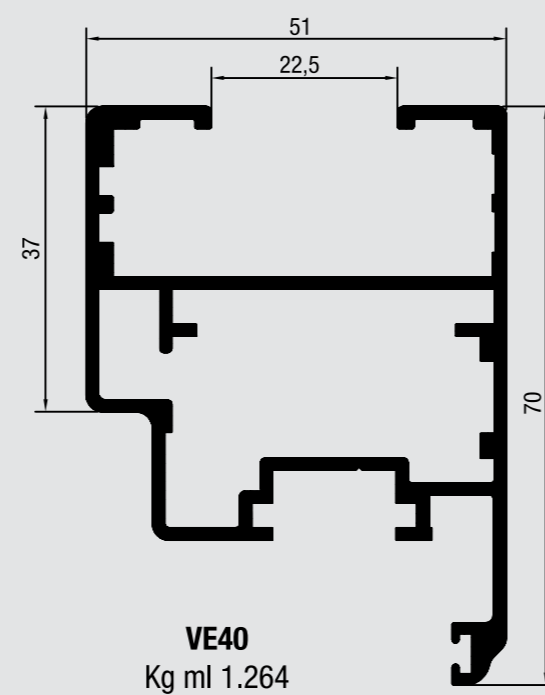
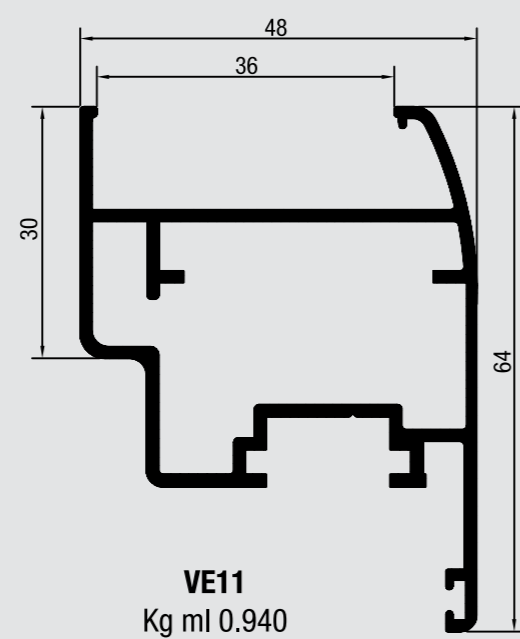
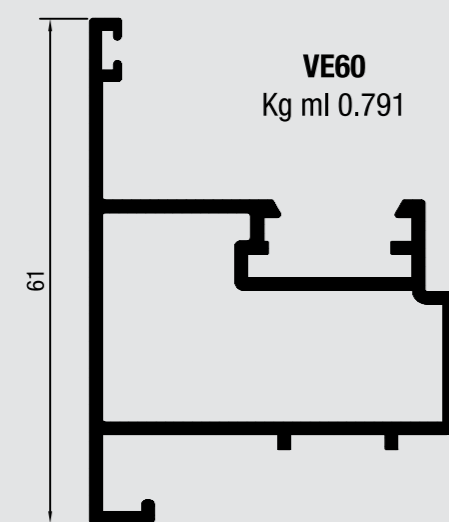
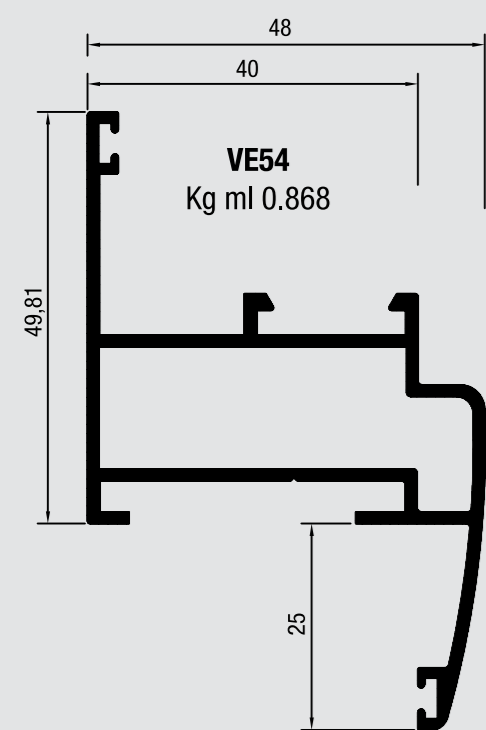
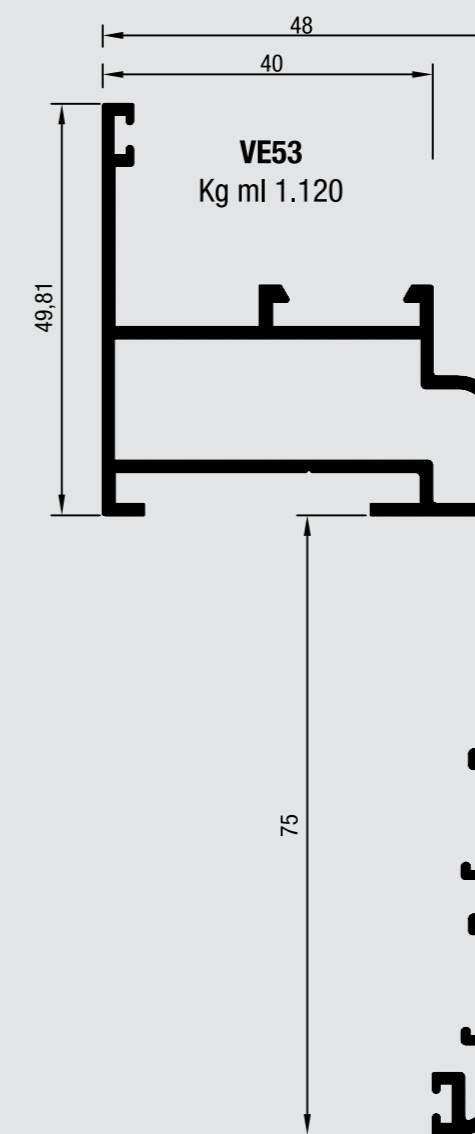
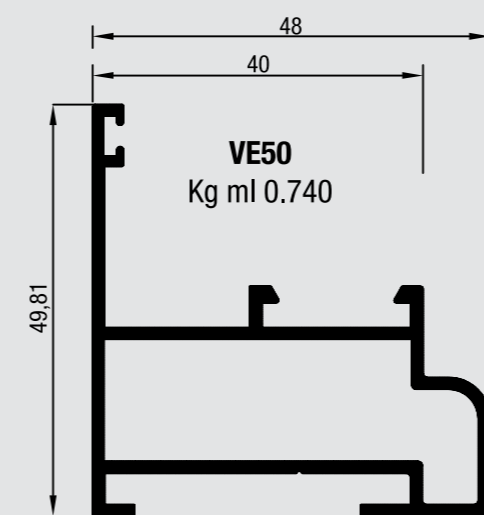
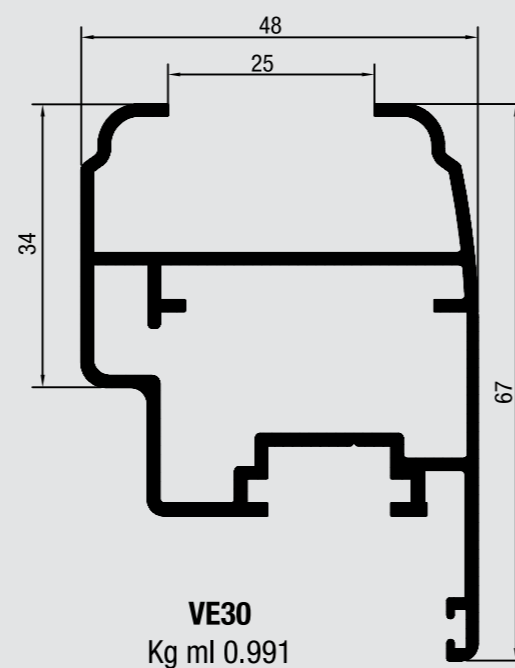
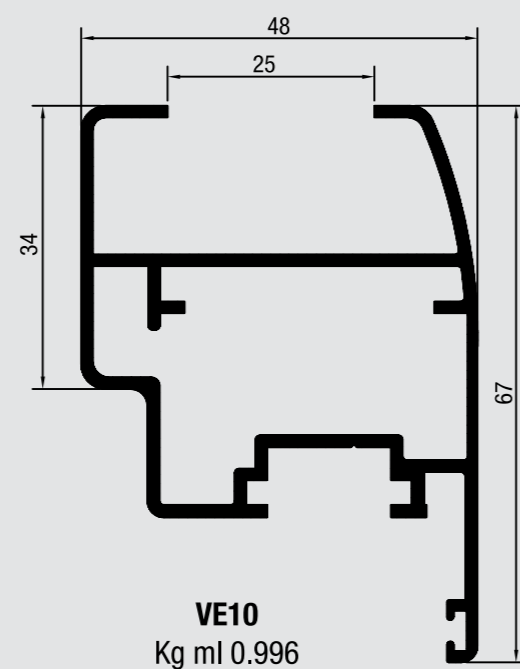
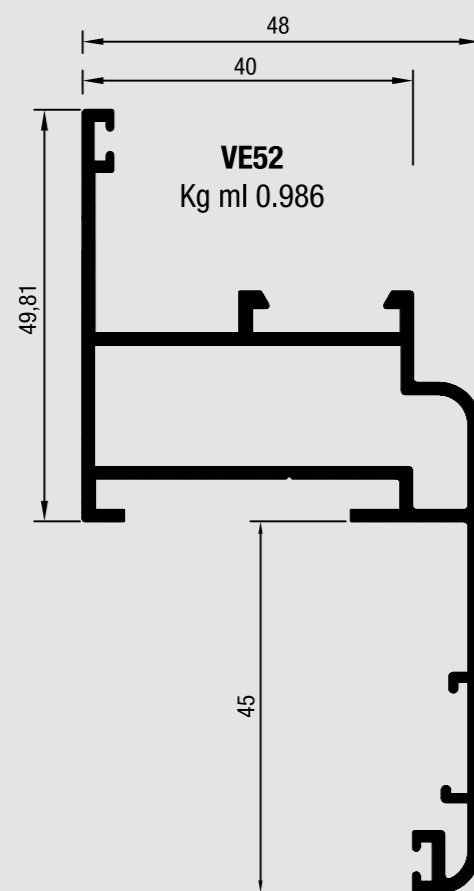
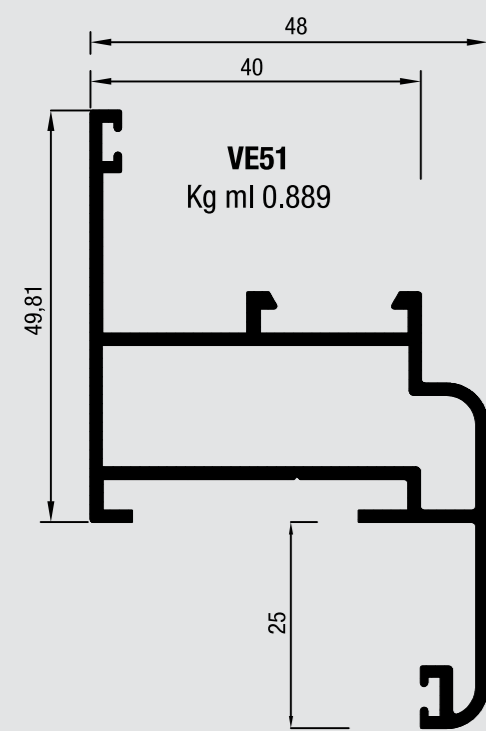

DISTINTE DI TAGLIO

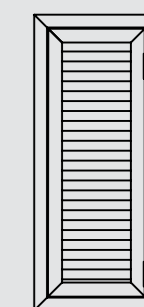

PERSIANA AD UN'ANTA. TELAIO 4 LATI

Articolo	Profilo	Descrizione	Tipologia	Taglio	Q.tà
VE51		Telaio		H +50	2
VE51		Telaio		L +50	1
VE50		Telaio		L	1
VE10		Anta		Ht -44	2
VE10		Anta		Lt -44	2

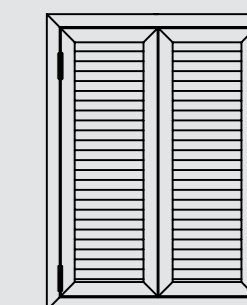

PERSIANA A DUE ANTE. TELAIO 4 LATI

Articolo	Profilo	Descrizione	Tipologia	Taglio	Q.tà
VE51		Telaio		H +50	2
VE51		Telaio		L +50	1
VE50		Telaio		L	1
VE10		Anta		Ht -44	4
VE10		Anta		Lt /2 -25	4
VE60		Riporto		Ht -109*	1

* dimensione indicativa